

E600 GNSS RECEIVER

USER GUIDE



V3.0

Copyright © Shanghai eSurvey GNSS Co., Ltd. 2021. All rights reserved.

No part of this document may be reproduced or transmitted in any form or by any means without prior written consent of Shanghai eSurvey GNSS Co., Ltd.

Trademarks and Permissions

 and other eSurvey trademarks are trademarks of Shanghai eSurvey GNSS Co., Ltd.

All other trademarks and trade names mentioned in this document are the property of their respective holders.

Notice

The purchased products, services and features are stipulated by the contract made between eSurvey and the customer. All or part of the products, services and features described in this document may not be within the purchase scope or the usage scope.

The information in this document is subject to change without notice. Every effort has been made in the preparation of this document to ensure accuracy of the contents, but all statements, information, and recommendations in this document do not constitute a warranty of any kind, express or implied.

Certificate



The device complies with part 15 of the FCC rules. Operation is subject to the following conditions:

- This device may not cause harmful interference.
- This device must accept any interference received, including interference that may cause undesired operation.

Contains FCC IDs: 2ABNA-2455A, 2ABNA-TRM121, XMR201903EG25G

Contains IC IDs: 11648A-2455A, 11648A-TRM121, 10224A-201903EG25G



This product has been tested and found to comply with European Council Directive 2014/53/EU, thereby satisfying the requirements for CE Marking and sale within the European Economic Area (EEA). Contains a radio module. These requirements are designed to provide reasonable protection against harmful interference when the device is operated in a residential or commercial environment.

Contents

1	Before You Start	1
1.1	Precautions for Safe Operation	1
1.1.1	Warning	1
1.1.2	Caution	1
1.2	Exemptions from Responsibility	2
2	E600 at a Glance	3
2.1	Appearance	3
2.2	Indicator Light.....	3
2.3	Power Button	4
2.4	Pin Port.....	4
2.5	Battery Slot	4
3	Web UI	5
3.1	Position	6
3.2	Datalink	7
3.3	Satellites.....	8
3.4	Information.....	9
3.5	Working Mode.....	10
3.6	Satellite Settings.....	11
3.7	Device Configuration	12
3.8	NMEA Message.....	13
3.9	View Logs.....	14
3.10	Raw Data	15
3.11	Backup Data.....	16
3.12	Management.....	17
4	Basic Operations	18
4.1	Insert a SIM Card and TF Card	18
4.2	Insert the Battery	18
4.3	Charge the Battery	18
4.4	Connect to the External Power.....	19
4.5	Install the Radio Antenna.....	19
4.6	Measure Antenna Height.....	20
4.7	Start Tilt Measurement.....	21
4.7.1	Start E-bubble Tilt Measurement.....	21
4.7.2	Start IMU Tilt Measurement.....	24
5	Internal Radio.....	25
6	Standard Accessories	26

1 Before You Start

Dear customers,



Thank you for purchasing our device. Before you start, please carefully read the following:

- This user guide is for your device only. If the actual situation does not match with the situation in the user guide, the actual situation shall prevail.
- For safety and instructions on how to use this device, please carefully read the precautions, exemptions from responsibility and instructions in the user guide.
- The information in this user guide is subject to change without notice. We reserve the right to change or improve the device as well the content in the user guide without any obligation to notify you. For any questions, please contact us.

1.1 Precautions for Safe Operation

For the safety of your product and prevention of injury to operators and other persons as well as prevention of property damage, please read this part carefully before using your product.

Precautions can be divided into the following types according to the degree of loss or injury in case of negligence or omission:

-  **WARNING:** Precautions requiring special attention. Ignoring this indication may possibly result in death or serious injury to the operator.
-  **CAUTION:** Precautions mainly for informing, such as supplementary instructions and using limitations. Ignoring this indication may possibly result in personal injury or property damage.

1.1.1 Warning

- Please do not disassemble the device. Otherwise, fire or electric shock may occur. Only e-Survey authorized distributors can disassemble or rebuild the device.
- Please do not cover the charger when charging. Otherwise, fire may occur.
- Please do not use wet charger, defective power cable, socket or plug, and power cable not specified by e-Survey. Otherwise, fire or electric shock may occur.
- Please do not put the device close to burning gas or liquid, and do not put it in the fire or high temperature condition. Otherwise explosion may occur.
- Please avoid short circuit of the battery. Otherwise, fire may occur.
- Please avoid disturbance of severe electrostatic discharge. Otherwise, the device may have some degradation of performance like switching on/off automatically, etc.

1.1.2 Caution

- Please put the device firmly on the pole.
- To avoid accidental damage, please only use original supplied parts. Otherwise, damage to the device may occur.
- When transporting, please try your best to lighten libration on the device.
- Please do not touch the device with wet hand. Otherwise, electric shock may occur.
- Please do not arbitrarily stand or seat on the carrying case, or turn over it. Otherwise, the device may be damaged.

1.2 Exemptions from Responsibility

You are expected to follow all operating instructions and regularly check the performance of this device.

We assume no responsibility for any damage and loss of profits caused by the following conditions:

- A faulty or intentional usage or misuse.
- Any disasters, such as earthquakes, storms, floods etc.
- A change of data, loss of data, an interruption of business etc.
- Wrong transport.
- Use of non-original parts.
- Usage not explained in the user guide.

2 E600 at a Glance

The E600 main body is designed with magnesium alloy material to provide durable usage and better heat dispersion, light weight 1300 g (two batteries inside), and two batteries.

2.1 Appearance

The E600 main body is as follows:



2.2 Indicator Light

Through the color of the indicator light, you can know the following:

- 📶
Satellite status
 - Off: no receiving satellites.
 - Green: fixed solution.
 - Flashing red: receiving satellites without no solution status.
 - Flashing green: have solution but not fixed.
 - Flashing red and green alternately: the mainboard abnormal.
- 📡
Datalink status
 - Green: datalink is ready to start.
 - Flashing green: datalink is transmitting data normally.
 - Flashing blue: light flashes according to the interval with raw data recording enabled.
- 🔋
Battery status
 - Green: battery level 30% - 100%.
 - Flashing green: battery level 10% - 30% (speaker will beep).
 - Flashing red: battery level below 10%.
- 📶
Bluetooth status
 - Off: Bluetooth not connected.
 - Blue: Bluetooth connected.

2.3 Power Button

Through the power button, you can achieve the following:

- Power on the receiver: long press the button for 3 seconds and release it. All indicator lights will be on.
- Power off the receiver: long press the button for 3 seconds, release it until you hear the voice *Power off?*, and press the button again.
- Broadcast the current mode: press the button after powering on. The receiver will broadcast the current working mode, including rover, base or static.
- Self-check: to troubleshoot the receiver when the receiver cannot work normally, long press the button for 2 seconds, release it until you hear the voice *Power off?*, and long press the button for 3 seconds until you hear the voice *Self-check*.

2.4 Pin Port

Through 5-pin port, you can connect an external radio and external power; and through 7-pin port, you can download data and output NMEA messages.

Pin definition is as follows:

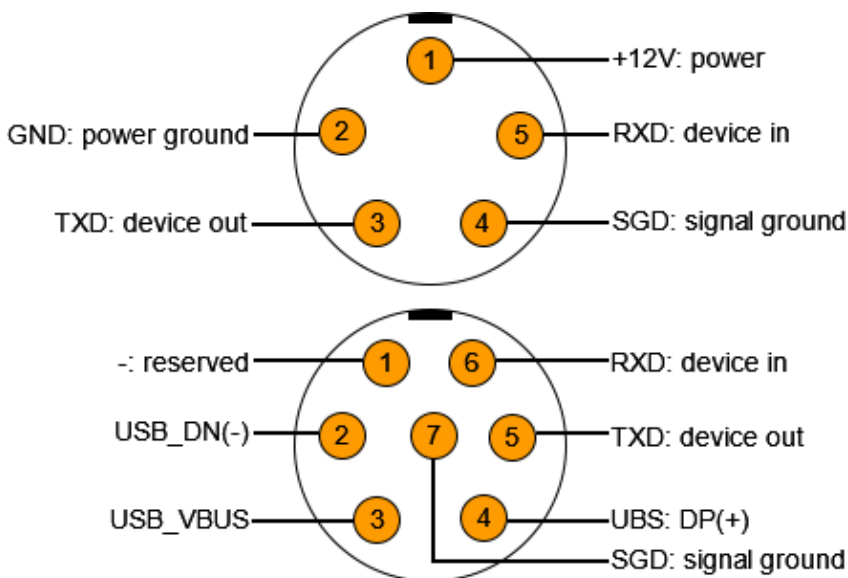

2.5 Battery Slot

There are two battery slots. Nano SIM card and TF card can be installed from slot A.

The dual battery slot design makes it possible to replace battery without interrupting the working.

3 Web UI

The receiver WIFI can be used as a hotspot, and you can connect to the hotspot with your PC, smart phone or tablet.

After connecting to the hotspot, you can manage working status, change working mode, configure basic settings, download raw data, update firmware and register device, etc.

Taking the interface of your PC as an example, to enter the Web UI, do the following:

1. Find the receiver WIFI hotspot with your computer.
Hotspot name: the device serial number
2. Open the web browser, and input IP address **192.168.10.1**. The following interface shows:

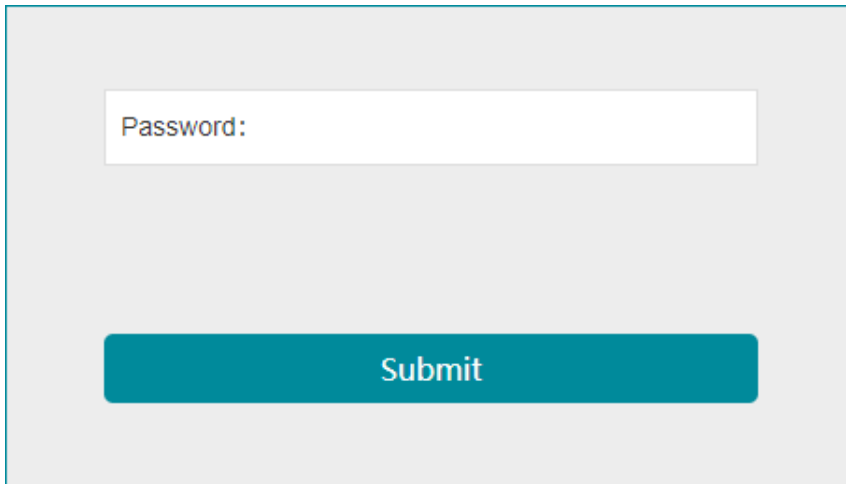

The image shows a web interface for password entry. It consists of a light gray rectangular area containing a white text input field with the label "Password:" and a teal "Submit" button below it.

3. Enter the password.
Default: password

3.1 Position

In **Position** page, you can view the following, and start and stop recording in static mode:

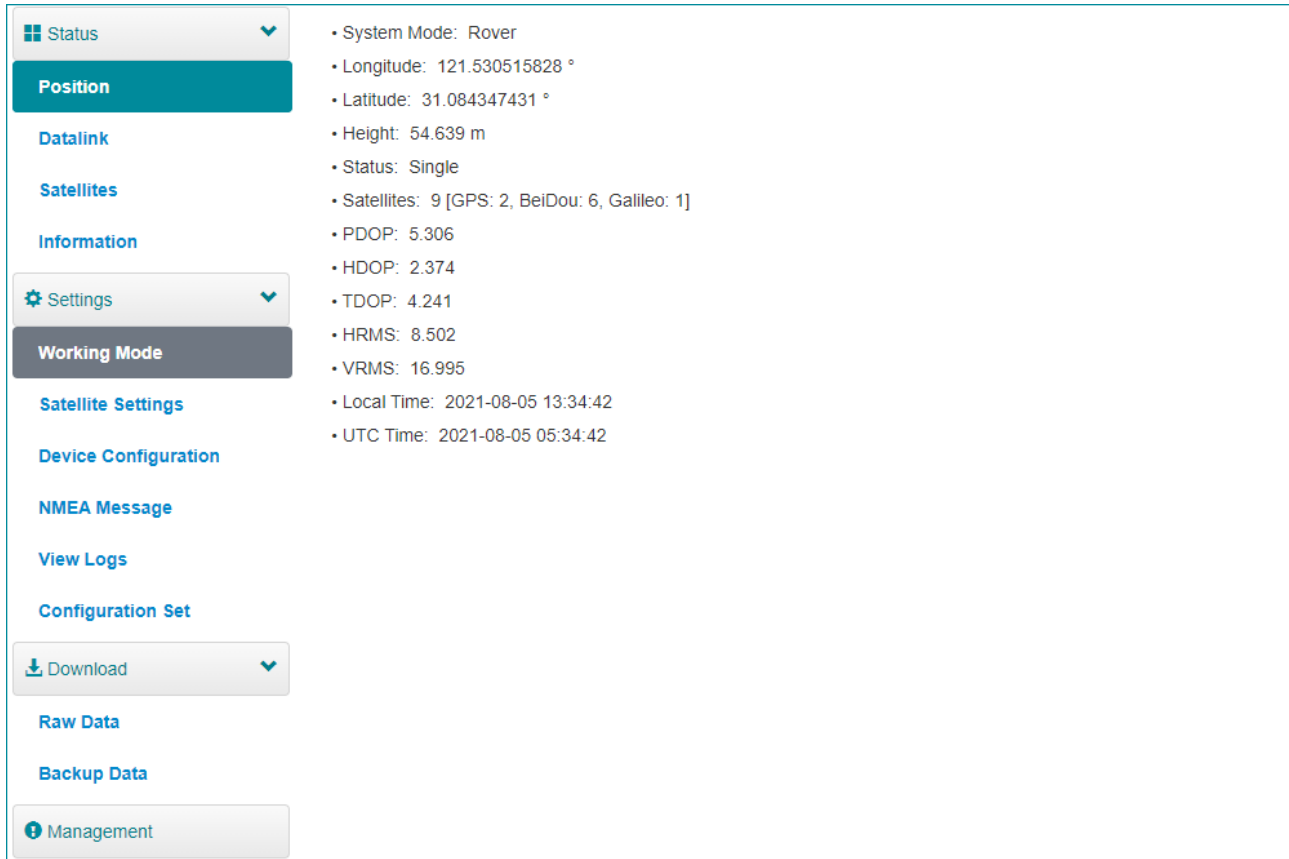

Status	• System Mode: Rover
Position	• Longitude: 121.530515828 °
	• Latitude: 31.084347431 °
Datalink	• Height: 54.639 m
Satellites	• Status: Single
Information	• Satellites: 9 [GPS: 2, BeiDou: 6, Galileo: 1]
Settings	• PDOP: 5.306
Working Mode	• HDOP: 2.374
Satellite Settings	• TDOP: 4.241
Device Configuration	• HRMS: 8.502
NMEA Message	• VRMS: 16.995
View Logs	• Local Time: 2021-08-05 13:34:42
Configuration Set	• UTC Time: 2021-08-05 05:34:42
Download	
Raw Data	
Backup Data	
Management	

- System node
- Coordinates: longitude, latitude, and height
- Solution status
- Satellite number
- PDOP
- HDOP
- TDOP
- HRMS
- VRMS
- Local time
- UTC time

3.2 Datalink

In **Datalink** page, you can check the current datalink:

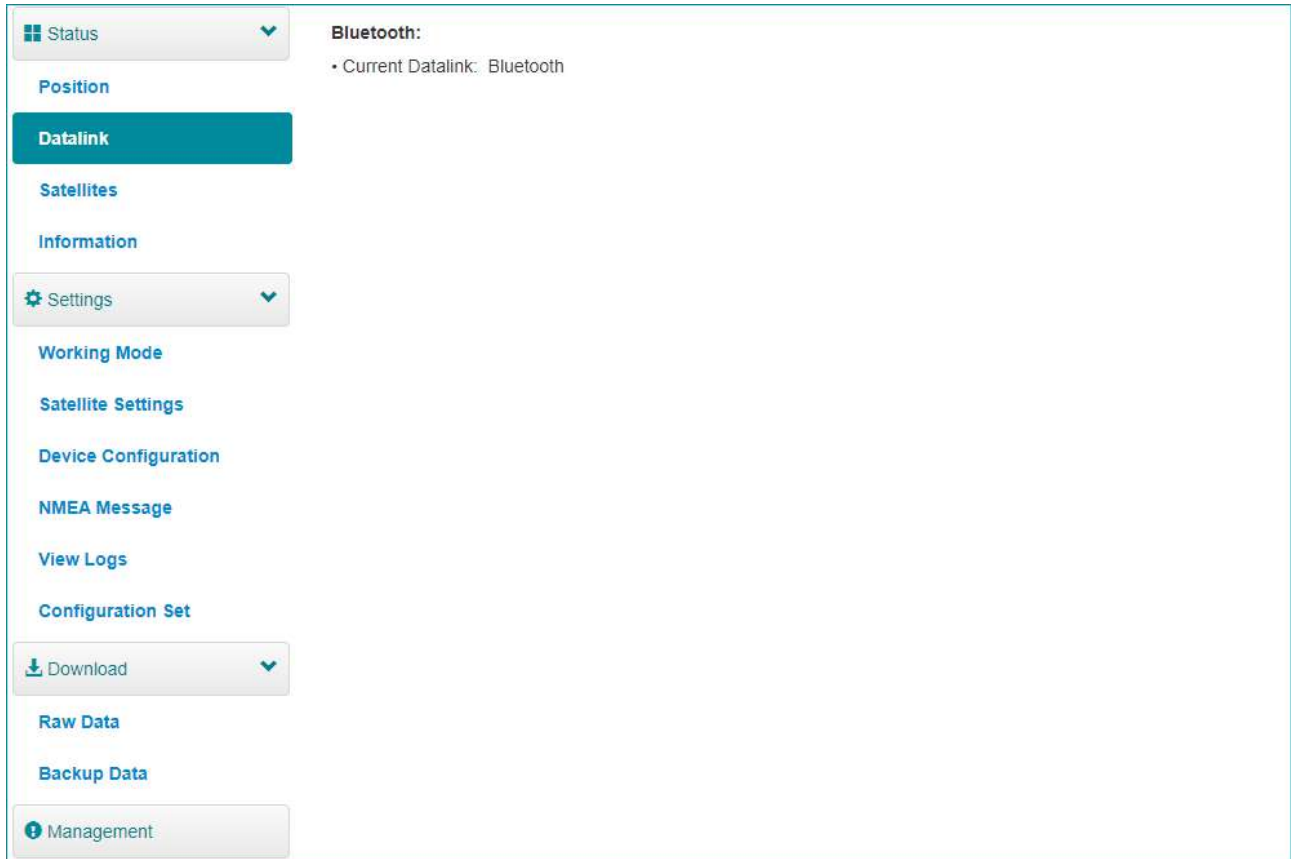

The screenshot displays the 'Datalink' page interface. On the left, a vertical sidebar menu lists various system functions: Status, Position, **Datalink** (the active page), Satellites, Information, Settings, Working Mode, Satellite Settings, Device Configuration, NMEA Message, View Logs, Configuration Set, Download, Raw Data, Backup Data, and Management. The main content area on the right is titled 'Bluetooth:' and shows a single entry: '• Current Datalink: Bluetooth'.

3.3 Satellites

In **Satellites** page, you can do the following:

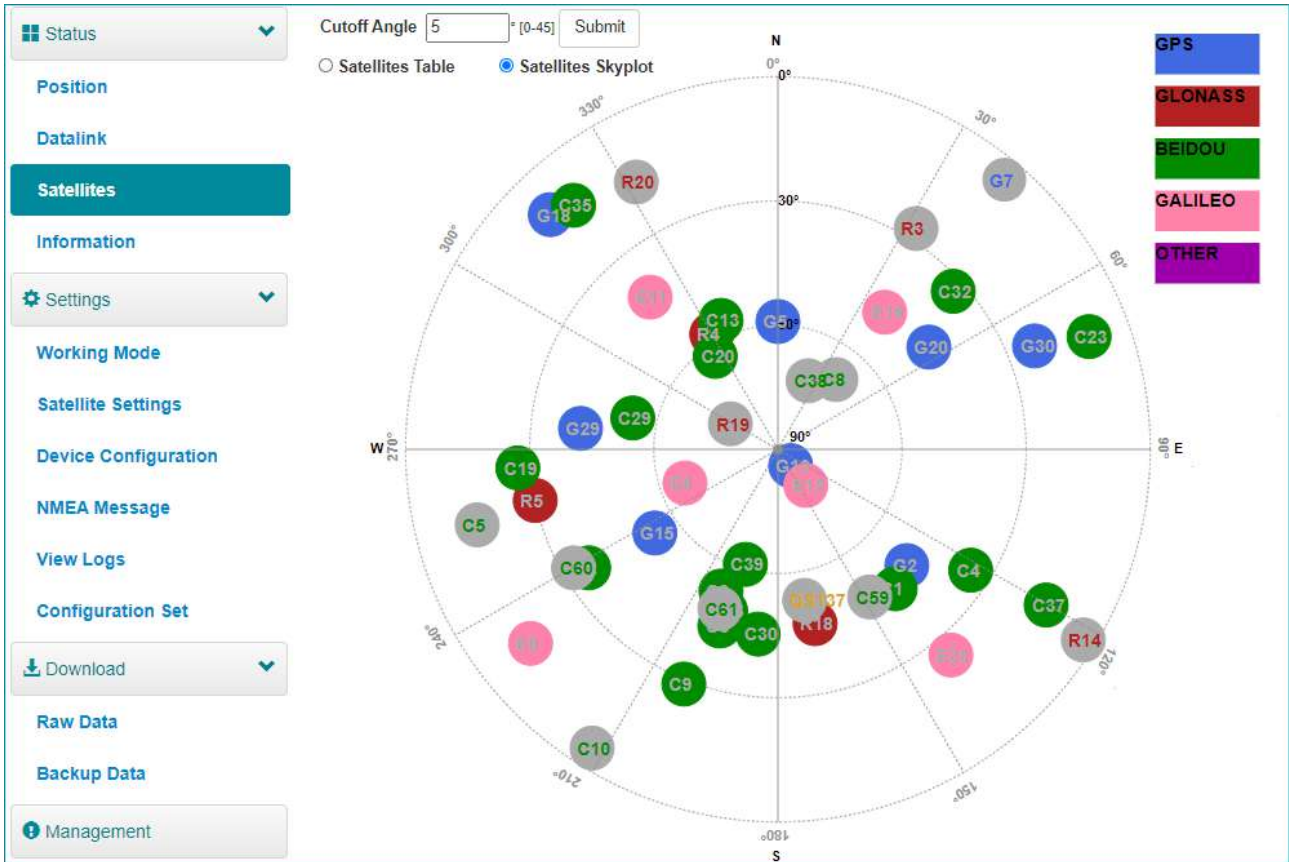

- Set cut-off angle
- View satellites in table or skyplot

3.4 Information

In **Information** page, you can view the following information:

<ul style="list-style-type: none"> Status Position Datalink Satellites <li style="background-color: #008080; color: white; padding: 2px;">Information Settings Working Mode Satellite Settings Device Configuration NMEA Message View Logs Configuration Set Download Raw Data Backup Data Management 	<p>Receiver: Device Model: E600 Hardware Version: V2.02 Firmware Version: 0.22.210618B MCU Version: 1.40 Battery 1: 76% Power Source: battery Manufacture Date: 2019-11-10</p> <p>Antenna: Antenna Type: ESVE600 H: 547 HL2: 61</p> <p>GNSS Board: GNSS Model: P328 GNSS Hardware Version: 1 GNSS Firmware Version: 5.9Aa08b</p> <p>Network: NETWORK Model: EG25-G Firmware Version: EG25GGBR07A07M2G Network Provider: Undefined Signal Level: Caster Address: :</p> <p>UHF: Radio Model: TRM101 Firmware Version: G001.02.16Q Radio Protocol: TrimMark III</p>	<p>Serial No.: E600351920019 BOOT Version: 1.16 OS Version: 1.19 Sensor Version: 1.3.4 Battery 2: 83% Data Memory: Internal Storage Total 6.74 GB; Free 6.74 GB</p> <p>R: 780 HL1: 154</p> <p>GNSS Serial: 19347855 GNSS BOOT Version: N/A</p> <p>IMEI: 867698040620489 Local IP: Network Type: Protocol: NTRIP Mountpoint: RTCM32</p> <p>Serial: TRU119044871 Channel: 4 [444.0000 MHz] Radio Power: HIGH</p>
---	--	---

- Receiver
- Antenna
- GNSS board
- Network
- UHF

3.5 Working Mode

In **Working Mode** page, you can configure the working mode, including base, rover and static:

The screenshot displays the 'Working Mode' configuration interface. On the left sidebar, the 'Working Mode' menu item is highlighted. The main configuration area includes the following options:

- System Mode:** Radio buttons for Static, Rover (selected), and Base.
- Current Datalink:** Radio buttons for UHF, Network, External, Bluetooth (selected), and a checkbox for Artk.
- Record Raw Data:** Radio buttons for NO (selected) and YES.

At the bottom of the configuration area, there are two buttons: a green 'Save' button and a white 'Cancel' button.

3.6 Satellite Settings

In **Satellite Setting** page, you can do the following:

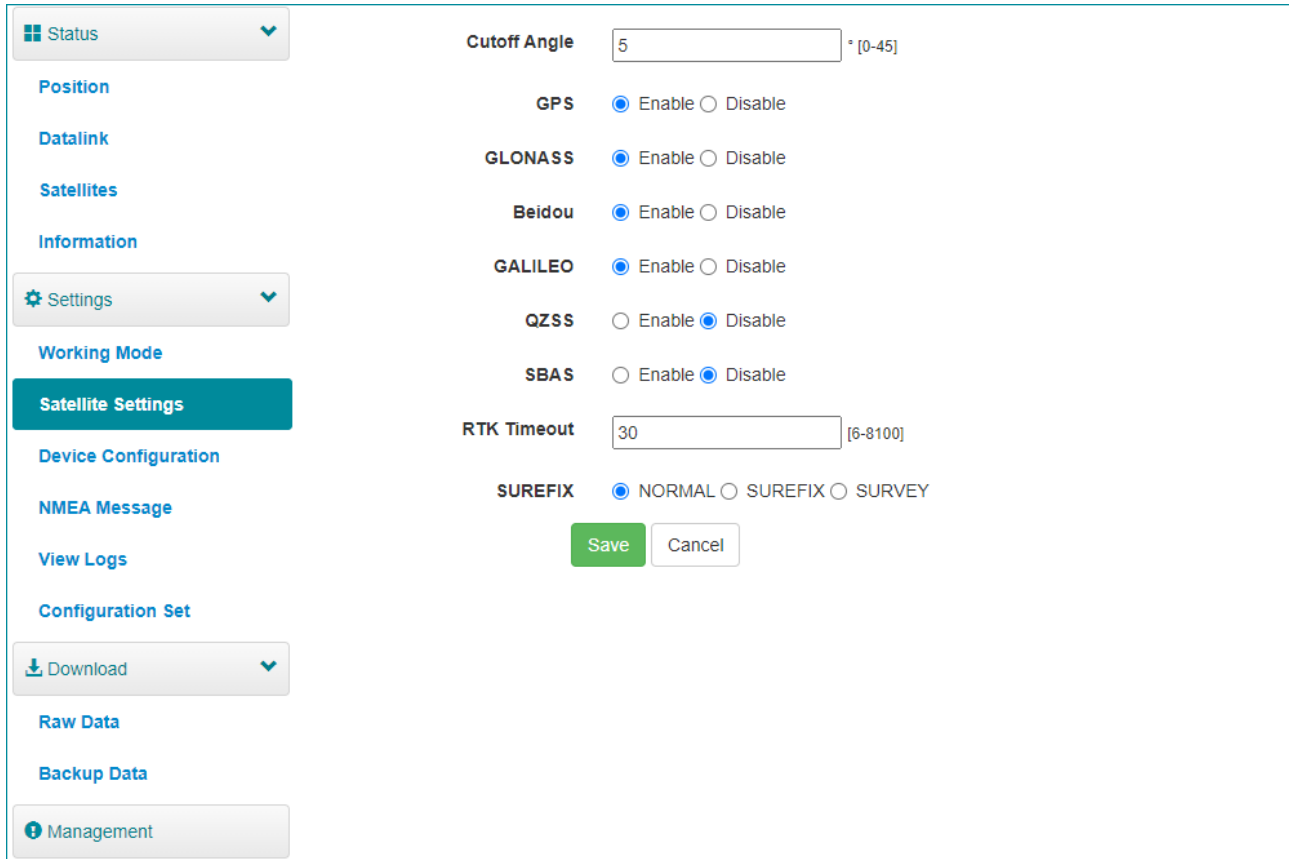

The screenshot displays the 'Satellite Settings' interface. The left sidebar contains a menu with the following items: Status, Position, Datalink, Satellites, Information, Settings, Working Mode, **Satellite Settings** (highlighted), Device Configuration, NMEA Message, View Logs, Configuration Set, Download, Raw Data, Backup Data, and Management. The main settings area includes:

- Cutoff Angle:** 5 [0-45]
- GPS:** Enable Disable
- GLONASS:** Enable Disable
- Beidou:** Enable Disable
- GALILEO:** Enable Disable
- QZSS:** Enable Disable
- SBAS:** Enable Disable
- RTK Timeout:** 30 [6-8100]
- SUREFIX:** NORMAL SUREFIX SURVEY

At the bottom of the settings area are 'Save' and 'Cancel' buttons.

- Configure the satellites to be used, including GPS, GLONASS, Beidou, GALILEO, SBAS and QZSS.
- Set RTK timeout: with Hemisphere L-Band service, high accuracy can be still kept within the set timeout even if correction data loses.
- Set surefix: the Hemisphere technology to increase the reliability of the fixed solution, which means it will be much more difficult to get fixed solution in tough environment.

3.7 Device Configuration

In **Device Configuration** page, you can do the following:

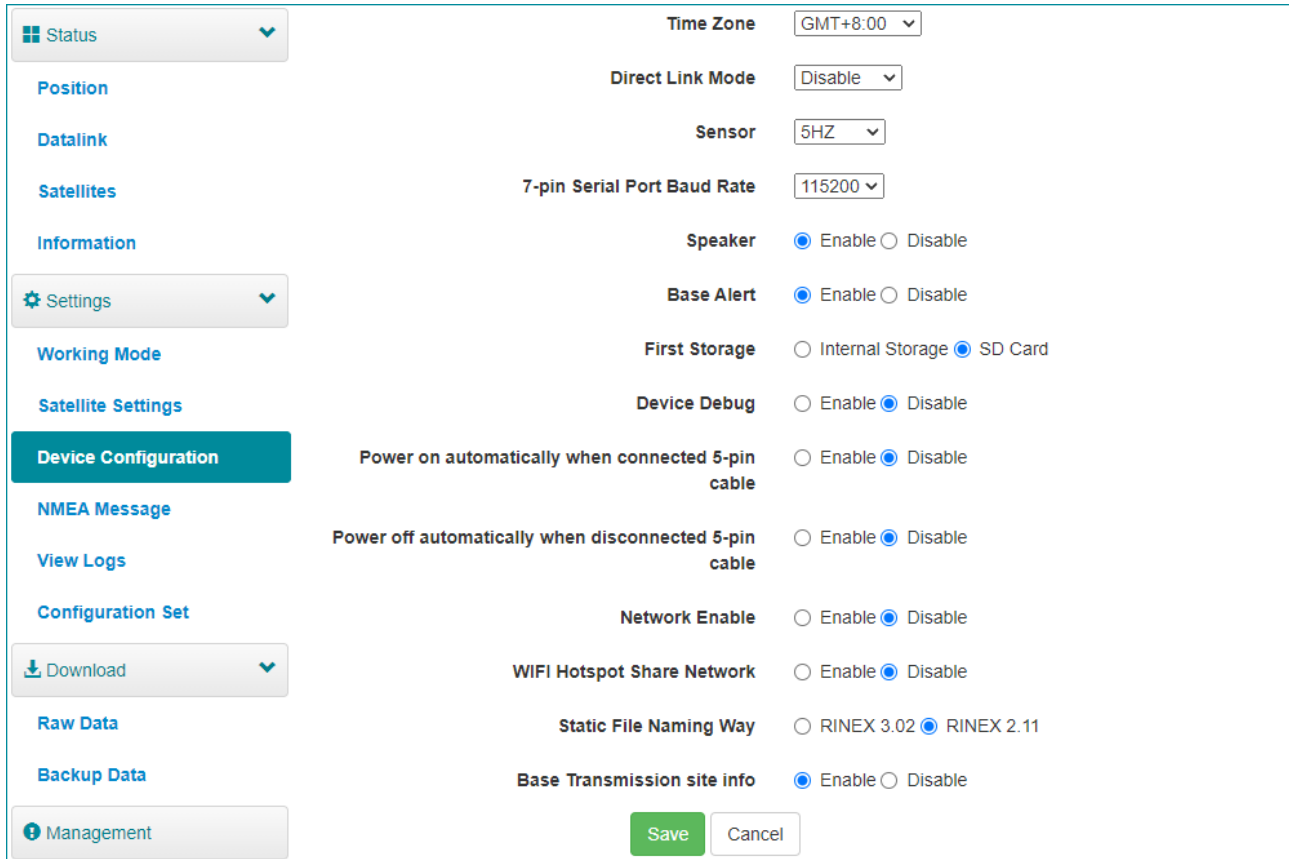

Status	Time Zone	GMT+8:00
Position	Direct Link Mode	Disable
Datalink	Sensor	5HZ
Satellites	7-pin Serial Port Baud Rate	115200
Information	Speaker	<input checked="" type="radio"/> Enable <input type="radio"/> Disable
Settings	Base Alert	<input checked="" type="radio"/> Enable <input type="radio"/> Disable
Working Mode	First Storage	<input type="radio"/> Internal Storage <input checked="" type="radio"/> SD Card
Satellite Settings	Device Debug	<input type="radio"/> Enable <input checked="" type="radio"/> Disable
Device Configuration	Power on automatically when connected 5-pin cable	<input type="radio"/> Enable <input checked="" type="radio"/> Disable
NMEA Message	Power off automatically when disconnected 5-pin cable	<input type="radio"/> Enable <input checked="" type="radio"/> Disable
View Logs	Network Enable	<input type="radio"/> Enable <input checked="" type="radio"/> Disable
Configuration Set	WIFI Hotspot Share Network	<input type="radio"/> Enable <input checked="" type="radio"/> Disable
Download	Static File Naming Way	<input type="radio"/> RINEX 3.02 <input checked="" type="radio"/> RINEX 2.11
Raw Data	Base Transmission site info	<input checked="" type="radio"/> Enable <input type="radio"/> Disable
Backup Data		
Management		

- Set time zone.
- Select whether to enable direct link mode, and IMU sensor data output.
- Set 7-pin serial port baud rate.
- Select whether to enable speaker (smart voice broadcast).
- Select whether to enable base alert.
- Select the storage directory (internal storage or SD card).
- Select whether to enable device debug.
- Select whether the power is on automatically when 5-pin cable is connected.
- Select whether the power is off automatically when 5-pin cable is disconnected.
- Select whether to enable network.
- Select whether to enable WIFI hotspot share network: with a SIM card inserted and it enabled, the device connected to the hotspot of the receiver (PC, smart phone or tablet) can surf the internet by using SIM data.
- Set naming method of static files.
- Select whether to enable base transmission site info.

3.8 NMEA Message

In **NMEA Message** page, you can do the following:

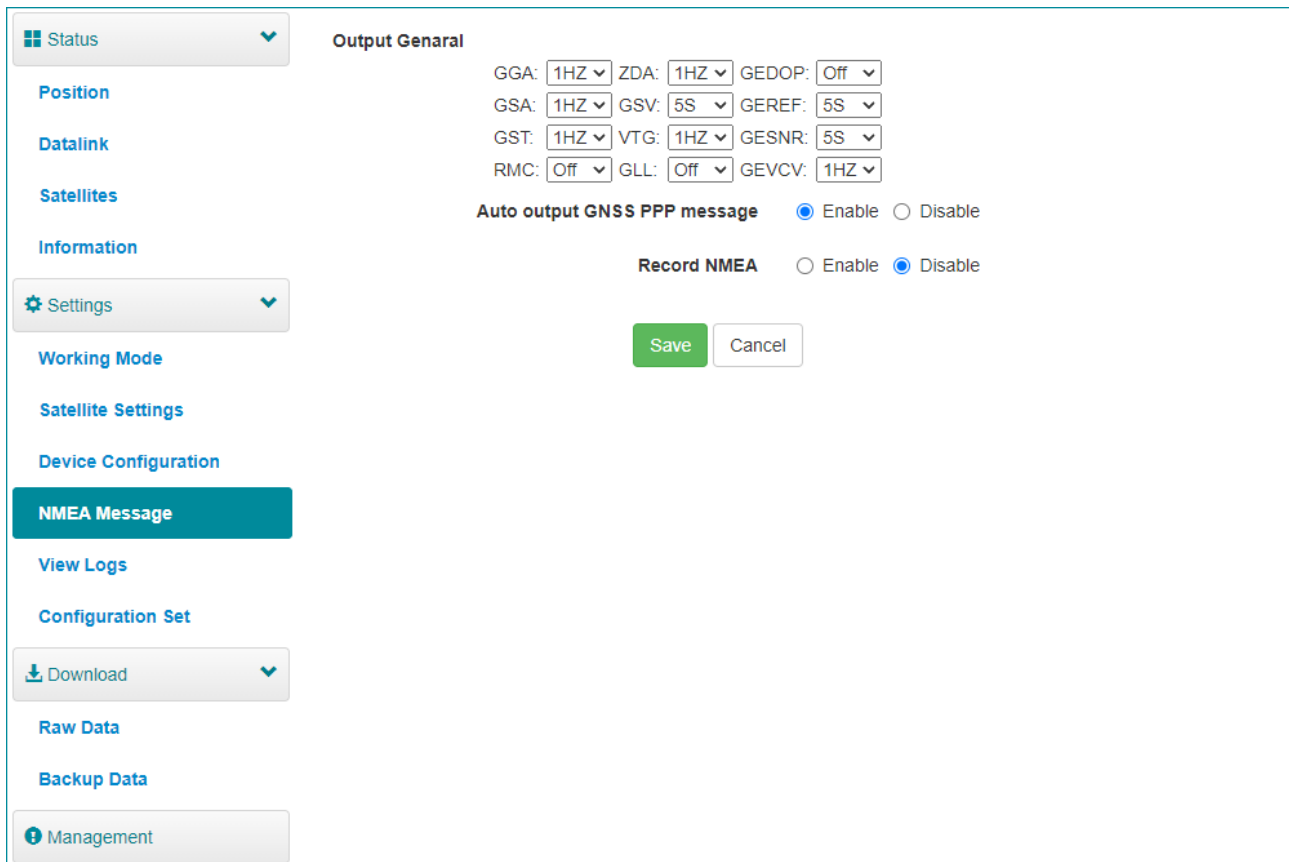

The screenshot displays the 'NMEA Message' configuration page. On the left is a navigation menu with options: Status, Position, Datalink, Satellites, Information, Settings, Working Mode, Satellite Settings, Device Configuration, **NMEA Message**, View Logs, Configuration Set, Download, Raw Data, Backup Data, and Management. The main content area is titled 'Output General' and contains the following settings:

- GGA: 1HZ, ZDA: 1HZ, GEDOP: Off
- GSA: 1HZ, GSV: 5S, GEREf: 5S
- GST: 1HZ, VTG: 1HZ, GESNR: 5S
- RMC: Off, GLL: Off, GEVCV: 1HZ
- Auto output GNSS PPP message: Enable Disable
- Record NMEA: Enable Disable

At the bottom of the configuration area are two buttons: 'Save' (green) and 'Cancel' (white).

- Configure NMEA data output through Bluetooth or 5-pin port.
- Select whether to enable automatic output GNSS PPP message.
- Select whether to record NMEA.

3.9 View Logs

In **View Logs** page, you can do the following for troubleshooting:

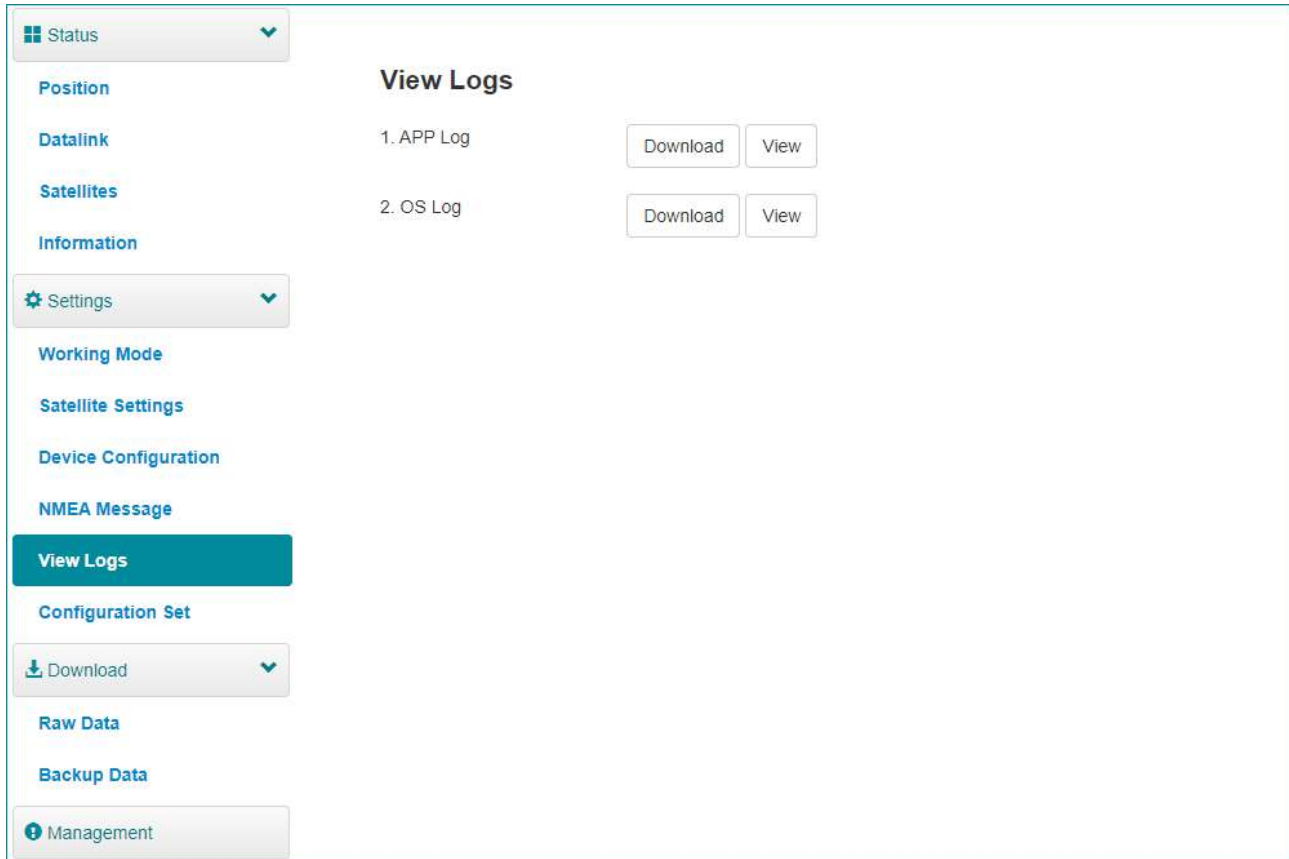

The screenshot displays the 'View Logs' interface. On the left is a sidebar menu with the following items: Status (dropdown), Position, Datalink, Satellites, Information, Settings (dropdown), Working Mode, Satellite Settings, Device Configuration, NMEA Message, View Logs (highlighted in teal), Configuration Set, Download (dropdown), Raw Data, Backup Data, and Management (dropdown). The main content area is titled 'View Logs' and contains a list of log entries:

Log Entry	Download	View
1. APP Log	Download	View
2. OS Log	Download	View

- View App logs and OS logs.
- Download files of App logs and OS logs.

3.10 Raw Data

In **Raw Data** page, you can do the following:

Status	Select	Name	Size (MB)	Antenna Height (m)	Start Time	End Time	Operation		
Position	<input type="checkbox"/>	20210730152058.nmea	0.045	-	-	-	Download	Delete	
Datalink	<input type="checkbox"/>	20210730152255.nmea	5.708	-	-	-	Download	Delete	
Satellites	<input type="checkbox"/>	20210803135050.nmea	14.768	-	-	-	Download	Delete	
Information	<input type="checkbox"/>	20210804091527.nmea	32.066	-	-	-	Download	Delete	
Settings	<input type="checkbox"/>	20210805090250.nmea	8.76	-	-	-	Download	Delete	
Working Mode	<input type="checkbox"/>	P0012101.dat	0.234	1.500	2021-07-29 17:30:46	2021-07-29 17:32:29	Convert	Download	Delete
Satellite Settings								Edit	
Device Configuration	<input type="checkbox"/>	P0022101.dat	1.142	1.500	2021-07-29 17:33:59	2021-07-29 17:41:36	Convert	Download	Delete
NMEA Message								Edit	
View Logs	<input type="checkbox"/>	P0022102.dat	0.316	1.500	2021-07-29 17:42:50	2021-07-29 17:45:03	Convert	Download	Delete
Configuration Set								Edit	
Download	<input type="checkbox"/>	P0022111.dat	19.197	1.500	2021-07-30 11:28:05	2021-07-30 13:38:19	Convert	Download	Delete
Raw Data								Edit	
Backup Data	<input type="checkbox"/>	selftest.log	0.001	-	-	-	Download	Delete	
Management	<input type="button" value="Select All"/> <input type="button" value="Package"/> <input type="button" value="Delete Selected"/>								

- Download raw data and NMEA data.
- Convert data to RINEX format.
- Download multiple files by checking the target files and clicking **Package**.

3.11 Backup Data

The points collected in SurPad software will be automatically backed up in receiver storage to avoid data loss. You can download the data for later use.

In **Backup Data** page, you can do the following:

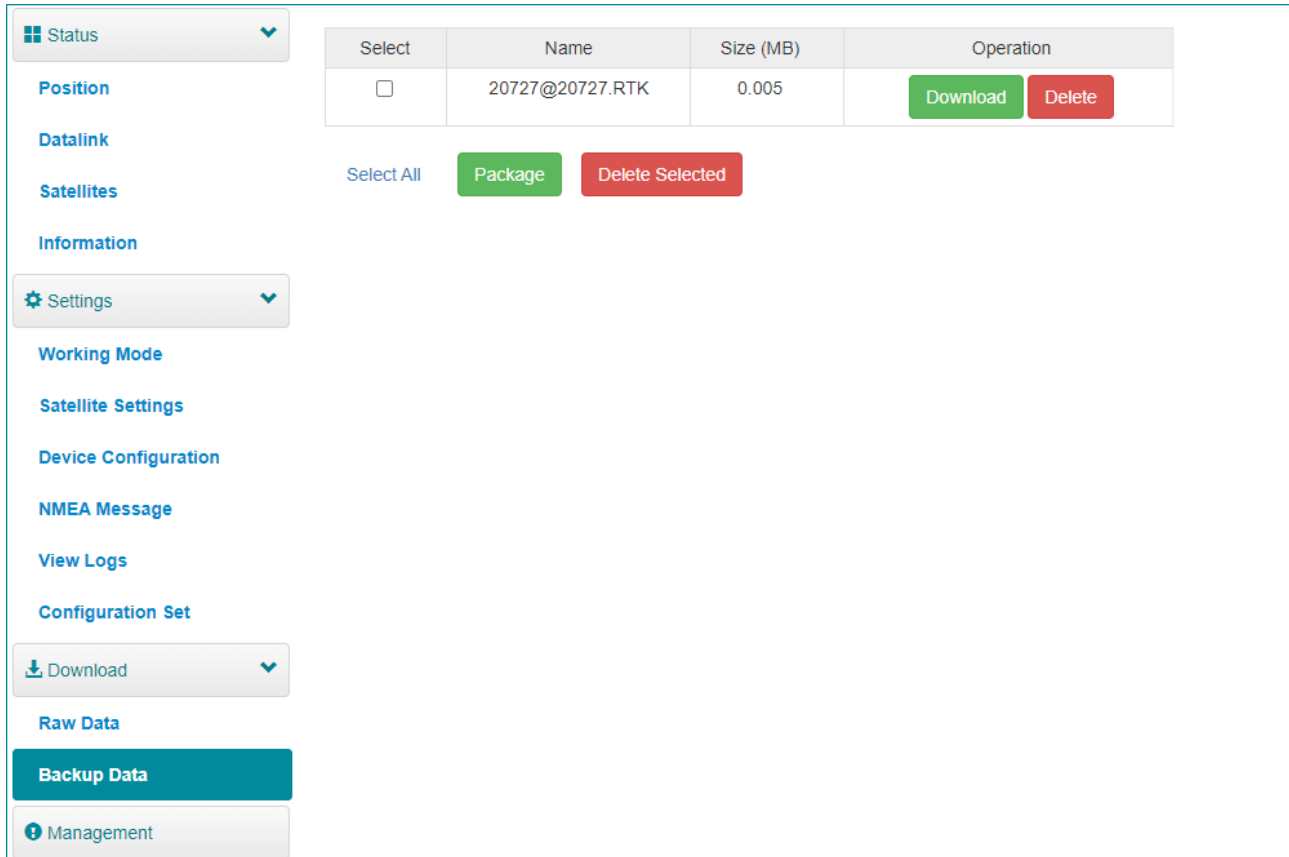

Select	Name	Size (MB)	Operation
<input type="checkbox"/>	20727@20727.RTK	0.005	<input type="button" value="Download"/> <input type="button" value="Delete"/>

- Download point data.
- Delete point data.

3.12 Management

In **Management** page, you can do the following:

<ul style="list-style-type: none"> Status Position Datalink Satellites Information Settings Working Mode Satellite Settings Device Configuration NMEA Message View Logs Configuration Set Download Raw Data Backup Data Management 	<h4>Install New Firmware ?</h4> <p>Choose File No file chosen Upload File</p> <hr/> <h4>Registration</h4> <p>Expire Date: 20211025 Function: L1+L2,GPS+Glonass+BeiDou+Galileo,50Hz,TiltOn AuthCode: <input type="text"/> Submit</p> <hr/> <h4>GNSS Registration</h4> <p>GNSS Functionality: 564;0;00/00/2000;8;OPT=;10Hz;RTK;L2_L5;MULTI_GNSS;HEADING;ATLAS_LBAND;China_Only AuthCode: <input type="text"/> Submit</p> <hr/> <h4>Security</h4> <p><input checked="" type="checkbox"/> Enable Login Authentication</p> <p>Old Password: <input type="text"/> New Password: <input type="text"/> Confirm Password: <input type="text"/></p> <p style="text-align: center;"><input type="button" value="Change"/></p> <p><input type="checkbox"/> Enable WIFI Connect Authentication The length of the wifi password must be greater than 7.</p> <p style="text-align: center;"><input type="button" value="Change"/></p> <hr/> <p>Format Internal Disk <input type="button" value="OK"/></p> <p>Self Test <input type="button" value="OK"/></p> <p>Restore Factory Settings <input type="button" value="OK"/></p> <p>Reset <input type="button" value="OK"/></p>
--	--

- Install new firmware.
- Register the device.
- Register the GNSS.
- Set security: to set password of web UI (192.168.10.1) and receiver WIFI.
- Format the internal disk.
- Do self-testing.
- Restore factory settings.
- Reset: to restart the receiver.

4 Basic Operations

It introduces basic process of starting working with the device.

4.1 Insert a SIM Card and TF Card

The device supports an external TF card with expansion up to 32 GB for static data storage, and a nano SIM card for network working mode.

To insert a SIM card and TF card, open the cover of battery slot A.

4.2 Insert the Battery

It is suggested to remove battery if the receiver is not in use for a long time.

To insert the battery, do the following:

1. Turn the battery cover lock to unlocked status.
2. Remove the cover of battery slot A / B.
3. Insert the battery and slide it as follows:



4. Put the cover back, and turn the battery cover lock to locked status.

4.3 Charge the Battery

The device is equipped with two batteries and you can charge the two batteries at the same time.

Before charging the battery, press the battery button on the battery to check the battery level:



Number of green indicator	Battery level
4	75% - 100%
3	50% - 75%
2	25% - 50%
1	0% - 25%

It takes 4 hours to fully charge the battery:

- Red indicator: the battery is in charging.
- Green indicator: the battery is fully charged.

To charge the battery, do the following:

1. Put the charger plug on the switching adapter, and connect the switching adapter and the charger.
2. Put the battery into the charger.

4.4 Connect to the External Power

Power supply from 5-pin port is supported, and the external battery within 9-28VDC is required.



CAUTION: It is not used for charging. Please use the original cable provided by us or cable with LPS standard.

To connect to the external power, open the cover of 5-pin port and connect one end of the cable to the 5-pin port and another end of the cable to the external battery.

4.5 Install the Radio Antenna

The antenna is required when the datalink is set to internal radio.

To insert radio antenna, open the cover of UHF radio, and install the radio antenna.

4.6 Measure Antenna Height

Antenna height refers to the vertical distance between the phase center and the ground. Since the antenna height cannot be directly measured, it is automatically calculated by SurPad software based on the measured height you input and measurement type you select.



CAUTION: No matter what the value of measured height you input and what kind of measurement type you select, the value of antenna height is unique.

The principle is as follows:

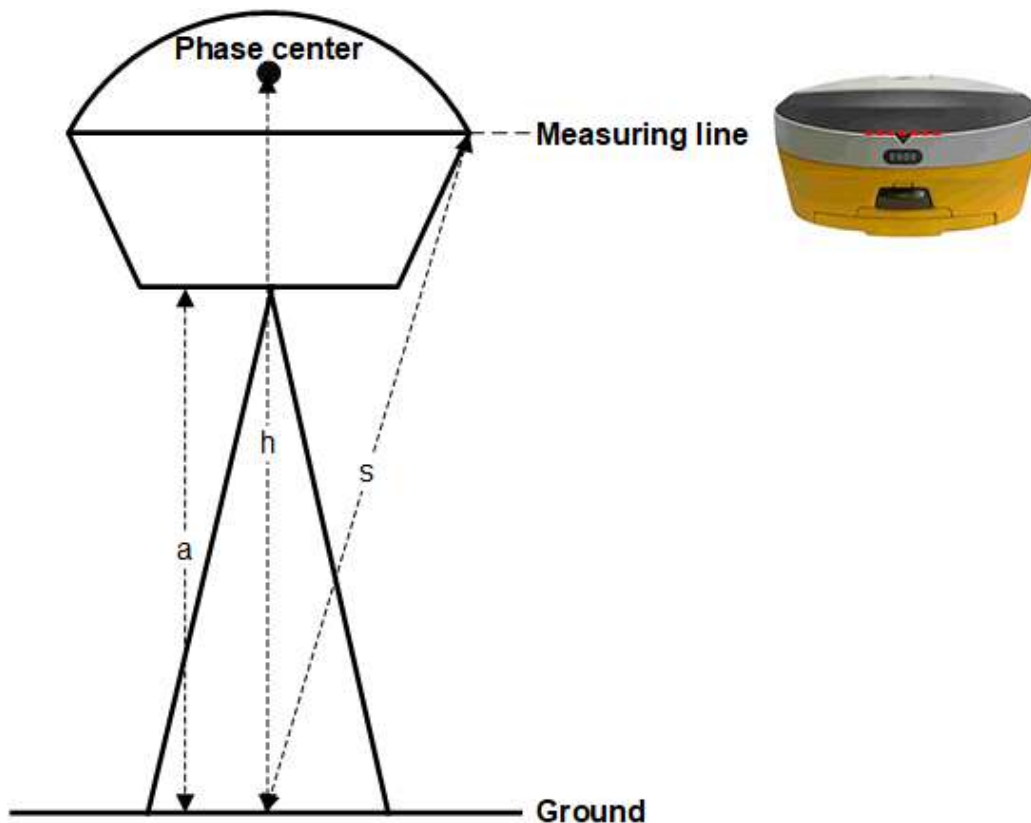

- **h**: the vertical height from the phase center to the ground.
- **s**: the slant height from the measuring line to the ground.
- **a**: the pole height, that is, the vertical height from the ground to the device bottom.

To measure antenna height, do one of the following:

- Set the measured height to the slant height and measurement type to slant height.
- Set the measured height to the pole height and measurement type to pole height.

The SurPad software automatically calculates the antenna height.

4.7 Start Tilt Measurement

The device can support both E-bubble and IMU, which is determined by the activation code and service you purchase, but you cannot use both of them at the same time.

4.7.1 Start E-bubble Tilt Measurement

It is required when tilt measurement is used and E-bubble is used.

Before starting E-bubble tilt measurement, to enable E-bubble tilt measurement, in SurPad software, press main menu **Device** → **Device Setting**, and set tilt survey to **E-Bubble**.

To Start E-bubble tilt measurement in SurPad software, do the following:

1. Press main menu **Survey** → **Point Survey** to enter the main interface of point

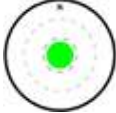
survey, select  in the point type area, and press . **Tilt Point** interface shows:

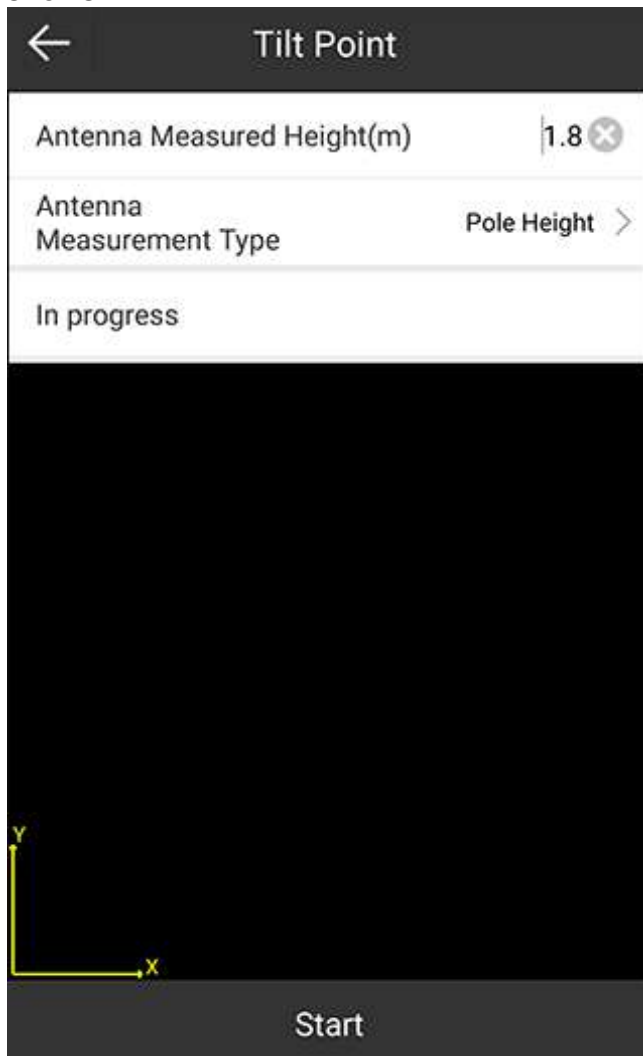

2. **Optional:** To modify antenna parameters, press **Antenna Parameters**, and set antenna parameters.
3. To start collecting tilt points, press **Start**.
4. Incline the pole with the inclined angle greater than 5°. The SurPad software automatically collects the first tilt point.

- 5. Change the inclined direction and repeat step 4 until 3 tilt points are collected. After 3 tilt points are collected, the following interface shows:

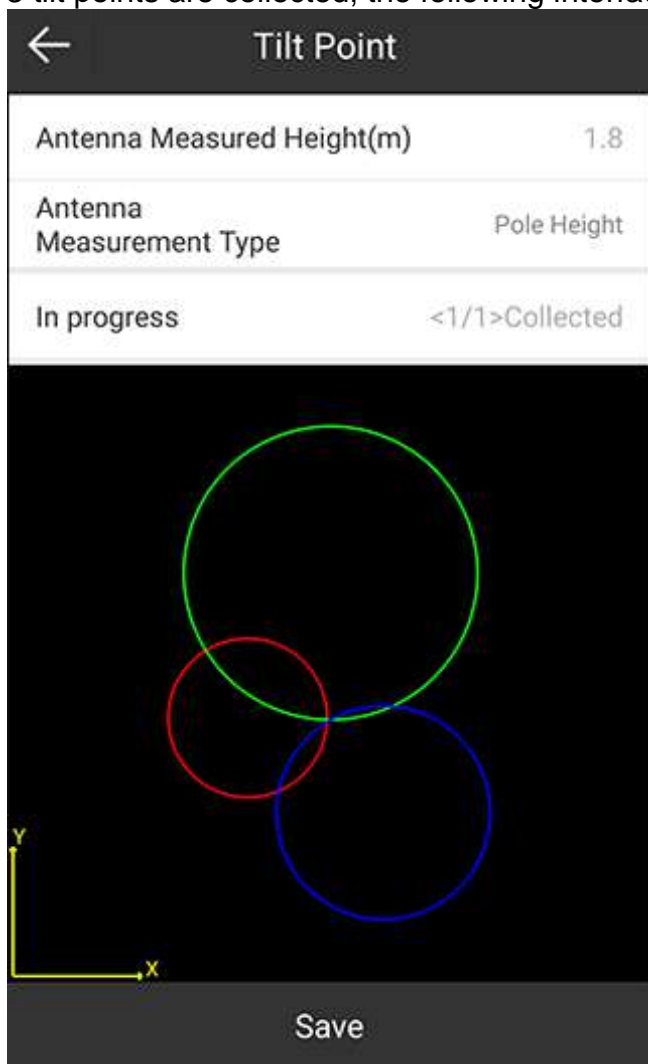

6. To save the result, press **Save**. The following interface shows:

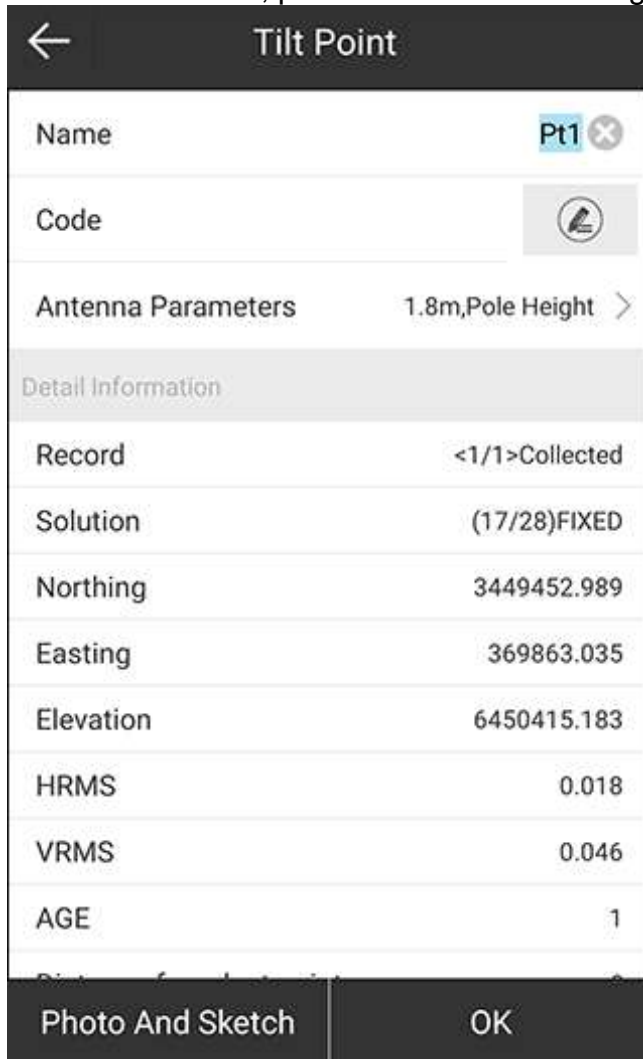





Tilt Point	
Name	Pt1
Code	
Antenna Parameters	1.8m, Pole Height
Detail Information	
Record	<1/1>Collected
Solution	(17/28)FIXED
Northing	3449452.989
Easting	369863.035
Elevation	6450415.183
HRMS	0.018
VRMS	0.046
AGE	1
Photo And Sketch	
OK	

4.7.2 Start IMU Tilt Measurement

It is required when tilt measurement is used and IMU is used.

Before starting IMU tilt measurement, to enable IMU tilt measurement, in SurPad software, press main menu **Device** → **Device Setting**, and set tilt survey to **Pole Tilt Correction**.

To start IMU tilt measurement in SurPad software, press main menu **Survey** → **Point Survey** to enter the main interface of point survey, and do as the prompt in the interface:

Status	What it means	What to do
	Magnetic calibration is required.	Take the pole and draw a circle towards the ground.
	Initialization is required.	Shake the pole or walk around.
	The accuracy of tilt measurement is not enough.	Wait for better signals.
	The tilt angle exceeds 60°.	Make sure the tilt angle is within 0° - 60°.
	Tilt measurement is successfully enabled.	Start survey.

5 Internal Radio

The device is equipped with 1 W internal radio. You can select the transmission power from 0.5 W or 1 W. There are 8 default channel frequency in which channel **8** is changeable. With firmware updated, lots of protocols in survey industrial are supported.

The default channel frequency is as follows:

Channel	Frequency (Unit: MHz)
1	441
2	442
3	443
4	444
5	445
6	446
7	447
8	448 (Changeable)

The supported radio protocol includes the following:











- Satel
- PCC-4FSK
- PCC-GMSK
- TrimTalk 450S
- South 9600
- HiTarget(9600)
- HiTarget(19200)
- TrimMark III
- South 19200
- TrimTalk(4800)
- GEOTALK
- GEOMARK
- 900M Hopping
- HZSZ
- GEO FHSS
- Satel_ADL
- PCCFST
- PCCFST_ADL



CAUTION: Some of the protocols may require firmware updating.

6 Standard Accessories

The standard accessories for the base station and rover station are as follows:

Items	Model	Description	Base	Rover	Picture
Base carrying case (1)	-	Carry case	√	√	
E600 GNSS receiver (1)	-	-	√	√	
Battery (2)	BP-5S	Li-ion battery, 7.2 V 3400 mAh	√	√	
Charger (1)	CH-04	Dual slots	√	√	
Switching adapter (1)	DSA-40CA-12	Adapter for CH-04	√	√	
Measuring tape (1)	-	3m / 10 ft - 16 mm	√	√	
UHF antenna (1)	-	-	√	√	
Extension pole (1)	-	25 cm	√	×	
Tribratch adapter (1)	-	-	√	√	
Plate antenna adapter (1)	-	-	√	×	
Warranty card (1)	-	-	√	√	



CAUTION: Standard accessories may change, and the actual accessories shall prevail.

*To be the leading provider of high-precision professional,
solution & service in the global geospatial industry*



Shanghai eSurvey GNSS Co., Ltd.

Address: Building 4, No.651 Wanfang Rd, Pujiang Town, Minhang District, Shanghai, China

E-mail: Sales: info@esurvey-gnss.com Support: support@esurvey-gnss.com

Hot-line: +86 21 54467213

Website: <https://esurvey-gnss.com/>